

6-GFM-180Ah

Valve-regulated Lead Acid Battery Specification

Features

- Maintenance free
- Safety and no leakage
- Excellent recharge and discharge performance
- Low self-discharge rate
- Adapt to high or low temperature
- Good deep discharge performance
- Longer cycle life



Specification

Rated Voltage	12V
Numbers of cells	6 Cells
Capacity	180Ah@10hr-rate to 1.80V per cell @25°C
Weight	54.3kg
Internal Resistance	Approx. 3.3 mΩ
Terminal	F8
Max. Discharge Current	2700A(5s)
Short Circuit Current	9000A
Max. Charging Current	45A
Reference Capacity	C10 180AH C3 138AH C1 99.4AH
Design Life	10~15 years
Float Charging Voltage	13.6 V~13.8 V @ 25°C Temperature Compensation: -20mV/°C/Cell
Cycle Use Voltage	14.4 V~14.9 V @ 25°C Temperature Compensation: -30mV/°C/Cell
Operating Temperature Range	Discharge: -15°C~50°C Charge: 0°C~40°C Storage: -15°C~40°C
Normal Operating Temperature Range	25°C±5°C
Self Discharge	Less than 3% at 25°C per month
Container Material	A.B.S. UL94-HB, UL94-V0 Optional.

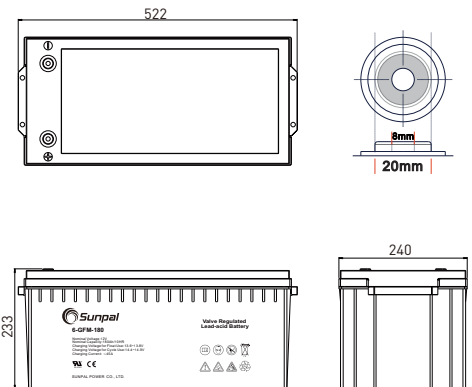

Length	522±2mm (20.6 inches)
Width	240±1mm (9.4 inches)
Height	219±1mm (8.6 inches)
Total Height	223±1mm (8.8 inches)

Constant Current Discharge Characteristics: A(25°C)

F.V/Time	5min	10min	15min	20min	30min	45min	1h	3h	5h	10h	20h
1.80V/cell	413.6	309.4	248.8	203.6	161.6	120.6	95.0	46.0	30.2	18.0	9.4
1.75V/cell	466.2	340.0	271.8	219.0	167.8	125.0	99.4	46.8	31.0	18.2	9.5
1.70V/cell	513.4	370.6	290.2	230.2	174.6	130.0	102.6	48.2	31.8	18.4	9.6
1.65V/cell	566.2	400.0	308.6	244.6	184.2	133.4	106.0	50.2	32.6	18.7	9.8
1.60V/cell	624.4	434.2	330.0	260.6	194.4	139.0	109.8	51.8	33.8	18.9	9.8

Constant Power Discharge Characteristics: WPC(25°C)

F.V/Time	5min	10min	15min	20min	30min	45min	1h	3h	5h	10h	20h
1.80V/cell	748.0	565.0	458.2	378.2	303.2	229.8	182.4	89.2	59.0	35.6	18.5
1.75V/cell	825.4	610.8	494.2	403.0	312.2	236.2	190.0	90.4	60.4	35.8	18.7
1.70V/cell	883.8	650.6	520.4	420.4	323.2	244.8	195.2	92.8	61.8	36.2	19.0
1.65V/cell	960.8	695.8	549.0	443.2	338.2	248.6	200.4	96.2	63.2	36.8	19.2
1.60V/cell	1035.2	738.2	577.4	467.0	354.4	257.8	206.4	98.8	65.0	37.2	19.3

6-FM-180Ah

Valve-regulated Lead Acid Battery Specification

Charge Characteristics for Float Use @ 25°C/77°F

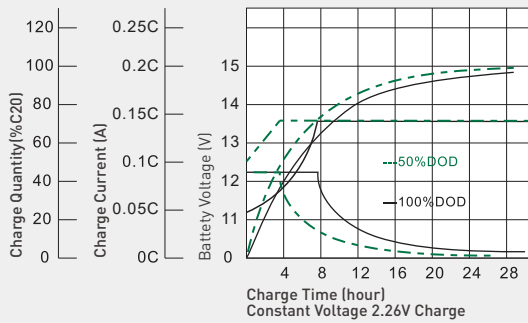

Discharge Characteristics at Various Rates @ 25°C/77°F

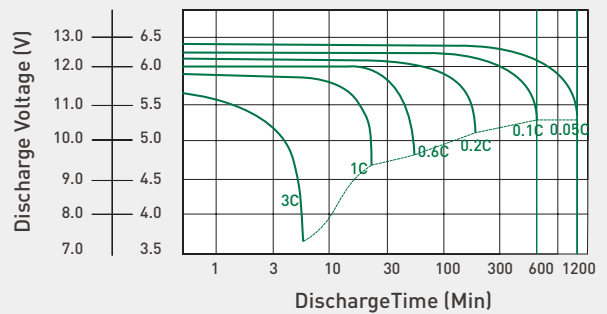

Cycle Life in Relation to Depth of Discharge

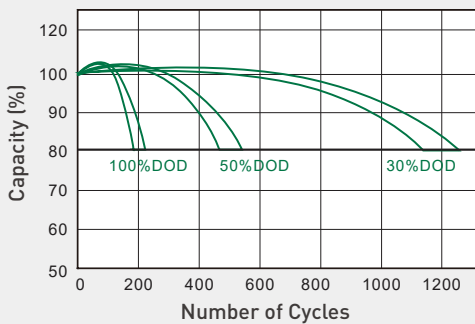

Float Service Life

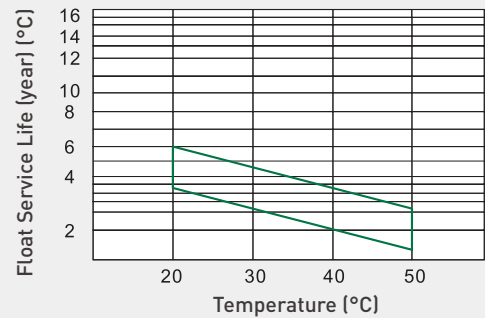

Temperature and Valid Capacity

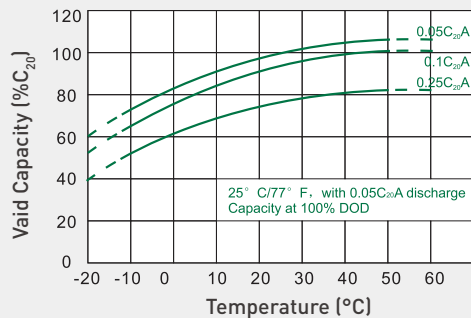

Self Discharge Characteristics

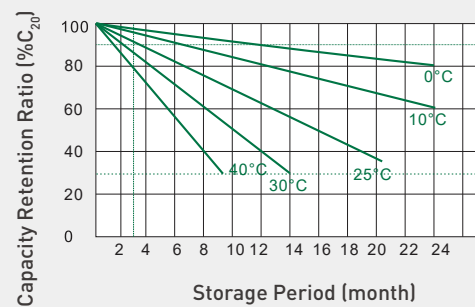

Capacity and Open Circuit Voltage

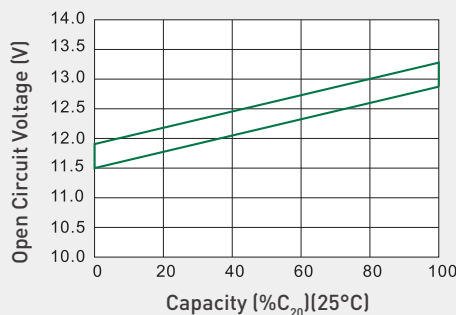

Relationship between Charging Voltage and Temperature

